

**MS100-120Y**

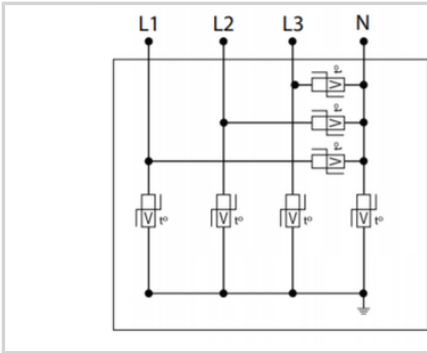

- Multi-TMOV Technology
- UL1449 Type 1 LISTED
- 105-220kA Surge Current Rating
- Visual fault indicator, audible alarm and remote contacts
- 10-Year warranty



Características eléctricas		
POWER SPD TYPE		UL1449 TYPE 1 LISTED
TENSION	(V)	120/208
AC/DC/DC PV/RF		AC
FASE	(PH)	3Y
AMPS	(A)	N/A
AMBIENT MIN	(C)	-35
AMBIENT MAX	(C)	+85
MODOS		L-L, L-N, L-G, N-G
VPR	(V)	1000/700/700/700
MCOV	(V)	300/150/150/150
IN	(kA)	20
I <sub>cc</sub> <i>cortocircuito</i>	(kA)	200
IMAX	(kA)	132
Características mecánicas		
TECNOLOGIA		Multi-TMOV
CONFIGURACION DE RED		3PH, 4W+G, Wye
FORMA DE CONEXION		36" #10 AWG LEADS
MONTAJE		FLANGE MOUNT
MATERIAL		Steel
NEMA RATING (IP RATING)		IP65
DESCONEXION SEGURA		Yes, no upstream over current protection required
REAL-TIME DIAGNOSTICS		% of protection present LED, audible alarm and remote contacts. Optional surge counter.
DIMENSIONS		See diagram
WEIGHT		6 lbs
Normas		
UL STANDARD		UL1449 5th Edition
UL CATEGORY		VZCA, VZCA7
UL FILE NUMBER		E326289
NORMAS		UL96A, ANSI C62.41/45, NOM-003-SCFI-2014, NOM-001-SCFI-1993, IEC61643-11
ENVIRONMENTAL STANDARDS		ROHS
Código		
890119		