

MS160-240D

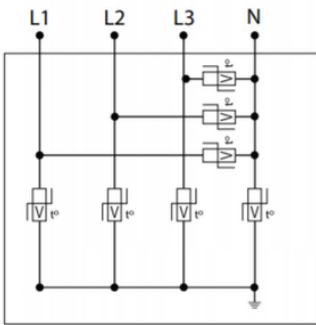

- ↳ I_{max} 105-220kA per phase
- ↳ UL1449 Type 1 Listed SPD
- ↳ I_n 20kA
- ↳ SCCR 200kA
- ↳ Real-Time LED indicators, Audible Alarm, Remote Contacts
- ↳ Smart Diagnostic Indicating % protection present
- ↳ NEMA 4 (Other options NEMA 12, NEMA 4X Stainless Steel)
- ↳ UL1283 EMI Filter (Option available)
- ↳ Surge Counter (Option available)



Características eléctricas		
POWER SPD TYPE		UL1449 TYPE 1 LISTED
TENSION	(V)	240
AC/DC/DC PV/RF		AC
FASE	(PH)	3Ø
AMPS	(A)	N/A
AMBIENT MIN	(C)	-35
AMBIENT MAX	(C)	+85
MODOS		L-L, L-G
VPR	(V)	1800/-/1200/-
MCOV	(V)	640/-/320/-
IN	(kA)	20
IMAX	(kA)	192
Características mecánicas		
TECNOLOGIA		Multi-TMOV
CONFIGURACION DE RED		3PH, 3W+G, Delta
FORMA DE CONEXION		36" #10 AWG LEADS
MONTAJE		FLANGE MOUNT
MATERIAL		Steel
NEMA RATING (IP RATING)		IP65
DESCONEXION SEGURA		Yes, no upstream over current protection required
REAL-TIME DIAGNOSTICS		% of protection present LED, audible alarm and remote contacts. Optional surge counter.
DIMENSIONS		See diagram
WEIGHT		6 lbs
Normas		
UL STANDARD		UL1449 5th Edition
UL CATEGORY		VZCA, VZCA7
UL FILE NUMBER		E326289
NORMAS		NOM-003-SCFI-2014, NOM-001-SCFI-1993
ENVIRONMENTAL STANDARDS		ROHS
Código		
890168		