



# CITEL

## SURGE PROTECTION FOR

- AC power line
- Photovoltaic system
- Led lighting
- High frequency coaxial line
- Telecom and dataline
- Gas discharge tube



# CITEL

## The global solutions provider



Since 1937, CITEL has been protecting installations around the world from transient overvoltages that result from switching events and lightning strikes.

Our teams all over the world are proud to help bring the market a comprehensive product range of surge protectors with our unique client-focused service & quality.



With a thorough understanding of local standards and regulations, along with continuous investment in R&D, CITEL designs, manufactures and sells millions of SPD's each year.

Unique, like each of our clients.

CITEL develops many critical protection components internally.

- Over 1 Billion Lines Protected
- Local support in over 200 countries
- High Current R&D Laboratories at your disposal



## TRANSIENT OVERVOLTAGES

### due to lightning

Today's increased reliance on very sensitive electronics and processes make surge protection an important discussion topic in order to avoid catastrophic business losses.

Mainly caused by lightnings, transient overvoltages (several kilovolts during a few microseconds) bring about important consequences in every network (AC, DC, Telecom, Data, RF). They may create disturbances, losses of data and even the full destruction of sensitive equipment.

### Multiples risks

In addition to the excessive amplitude of transient overvoltages, multiple modes of aggression increase the risk of equipment failure in installations.

1. Direct Strike



2. Earth Potential rise



3. Strike on overhead lines



4. Coupling

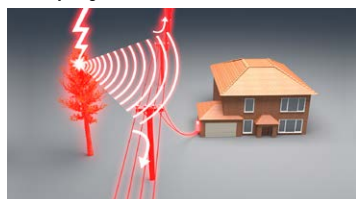

## SURGE PROTECTORS

### The only effective protection

The goal is to limit the overvoltages to a level in compliance with the electrical withstand of the terminal equipment to be protected.

The SPD has to :

- provide the lowest residual voltage as possible,
- provide a discharge capacity adapted to the real risks,
- avoid disturbances of operation for the equipment.

These parameters will be reached by selecting the relevant surge protectors, as well as installing them in the correct way. Easy to use and efficient, CITEL surge protectors have been designed following the main international standards.

### All networks are concerned

CITEL provides a wide range of surge protectors adapted to every network: AC power , DC power, Telecom, Data and RF .

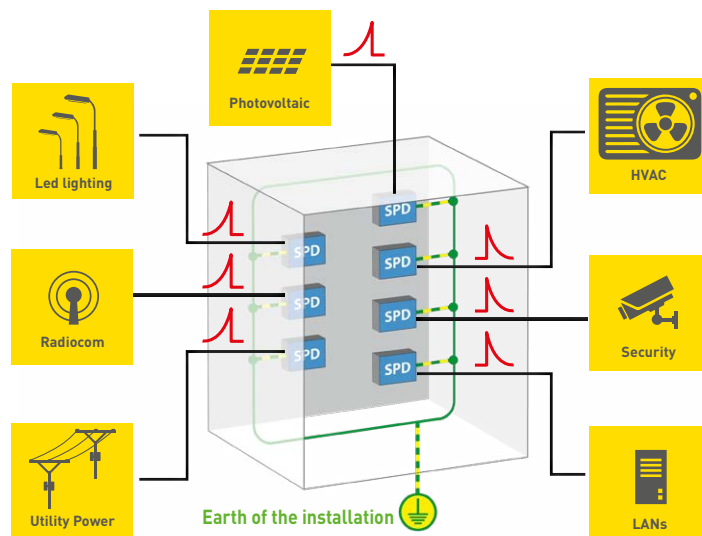

 Transient overvoltages



# AC SURGE PROTECTORS

## DAC - DS Range

- ✓ New surge protectors range: DAC
- ✓ Full range of AC Surge Protection Type 1 and Type 2
- ✓ In compliance with EN and IEC standards
- ✓ Pluggable version / DIN Rail mounting design
- ✓ Discharge current :  $I_{max} > 140 \text{ kA}$  -  $I_{limp} > 25 \text{ kA}$
- ✓ Different operating voltages
- ✓ Safety thermal disconnection and remote signalling
- ✓ Available in VG Technology

DAC and DS surge protectors are based on MOV or MOV+GSG technology (patented "VG" technology) which are the best combination to provide high discharge current capability and low residual voltage. The Type 1 versions have been designed to improve safety in low voltage networks by avoiding follow currents.

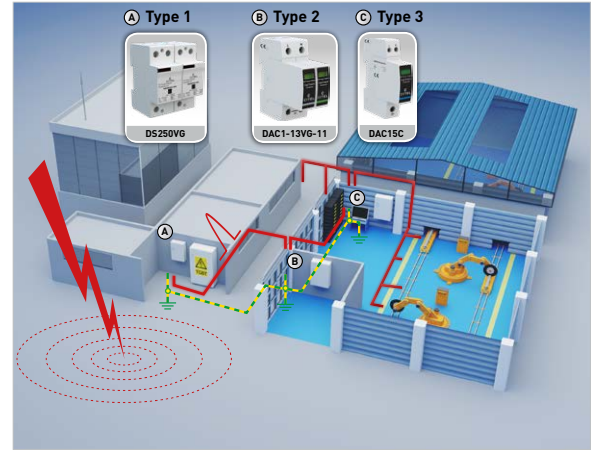

Series	Type	$I_{max}$	$I_{limp}$	Specificity
DS250VG	1+2+3	-	25 kA	High energy
DAC1-13	1+2	-	12,5 kA	Pluggable
DS70R	2	70 kA	-	Type 2 reinforced
DAC50	2	50 kA	-	Type 2 standard
DAC40C 1-phase	2	40 kA	-	Single phase Compact
DAC15C 3-phase	2	15 kA	-	3-phase Compact

# SURGE PROTECTORS FOR PHOTOVOLTAIC SYSTEM

## DS-PV range

- ✓ Complete range for photovoltaic installation
- ✓ Type 1 and Type 2 DC surge protectors
- ✓ Plug-in version
- ✓ Available voltages : 500, 600, 800, 1000 and 1500 Vdc
- ✓ Safety disconnection and remote signalling
- ✓ IEC 61643-31 compliance

DS-PV surge protectors have been designed to protect efficiently the PV inverters and operate safely on the PV networks. They are available in Type 1 and Type 2, and for all the main DC voltages.

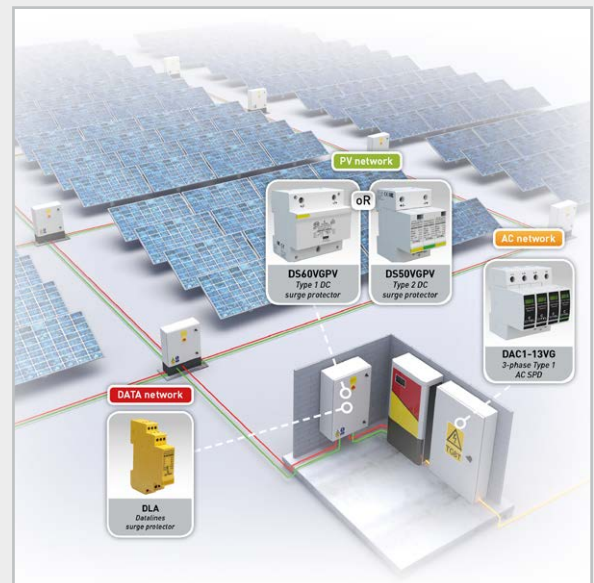

# LED LIGHTING SURGE PROTECTORS

- ✓ Configurations Class I and Class II
- ✓ Compact dimensions
- ✓ IP20 and IP65 versions
- ✓ Combined AC / Data version
- ✓ Connection: wire or screw or spring contact
- ✓ Maximal discharge current 10 kA
- ✓ Remote signalling (option)
- ✓ IEC 61643-11 and EN 61643-11 compliance

CITEL offers a full range of surge protectors designed to be installed at different points on the lighting network such as streetlights, the base of poles and street cabinets. For every type of outdoor LED lighting systems: urban, architectural, tunnels etc...



DLPM1-230L

DSLP1-230L

MLPC1-230L-R

MLPX1-230/W

# TELECOM/DATA SURGE PROTECTORS

**A comprehensive range of surge protectors for the most common of transmission lines.**

- ✓ Very short response time (less than 1 ns)
- ✓ Gas tube for high discharge current capability
- ✓ Fail safe behaviour in case of permanent failure
- ✓ Mounting: on telecom MDF, wall, DIN Rail
- ✓ Telecom Applications: PSTN, ISDN, ADSL, VDSL, HDSL ....
- ✓ Data Applications: RS485, RS422, 0-20mA, Profibus....
- ✓ IEC/EN 61643-21 compliance
- ✓ Signalisation and Remote signalling version

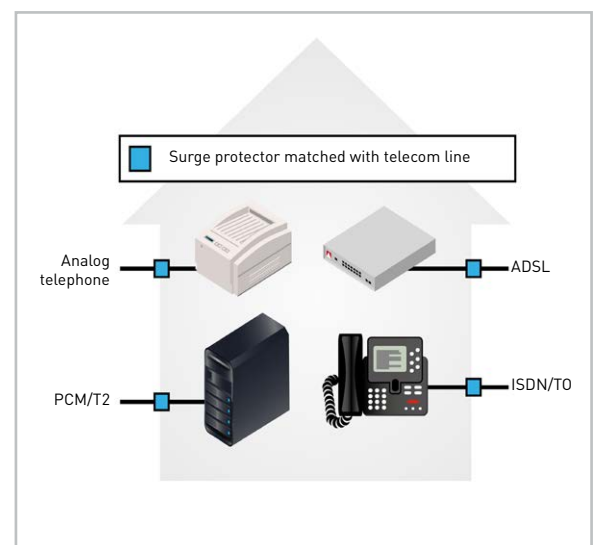

DLA

DLU

DLC

DLAS

DLATS

MJ6-1T

MJ8



# DATALINE SURGE PROTECTORS

- ✓ Very short response time (less than 1 ns)
- ✓ Gas tube for high discharge current capability
- ✓ Low voltage line and high bitrate (up to 10 Gbit/s)
- ✓ Connectors : RJ45, Coaxial...
- ✓ Applications : Ethernet Cat 5E, Cat 6A, PoE++ ...

Ethernet network surge protectors are designed for computer networks with very fast data transfer speeds up to 10 Gbit/s for the Category 6 networks. Several models are available to adapt to all the configurations of dataline installations.

These surge protectors are in compliance with EN 61643-21 standard.

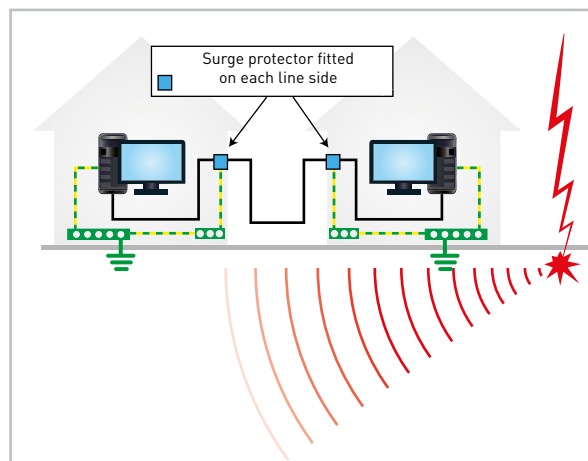

MJ8-POE  
Indoor POE SPD



CRMJ8-POE  
Outdoor POE SPD



MSP-VM  
3-way survey camera



CXC  
Video coaxial SPD



DD15  
Multi-port Ethernet



PL  
POE rack mounted SPD



# RF SURGE PROTECTORS

Citel offers several surge protection technologies for RF lines :



**"Quarter Wave":**  
PRC series

- ✓ "Filtering" operation
- ✓ 0,5 up to 6 GHz
- ✓ I<sub>max</sub> : 100 kA
- ✓ Residual voltage : a few volts
- ✓ No DC power on coaxial cable
- ✓ No ageing



**"Gas Tube":**  
P8AX series

- ✓ "Sparkover" operation
- ✓ DC up to 6 GHz
- ✓ I<sub>max</sub> : 20 kA
- ✓ Residual voltage < 300 V
- ✓ Removable GDT for optimized maintenance



**"Gas Tube + Diode":**  
CX series

- ✓ 2 diagrams : Gas discharge Tube (CXP) or GDT + Diodes (CXC)
- ✓ Very low insertion loss
- ✓ Bandwidth up to 1000 MHz
- ✓ I<sub>max</sub> : 10 kA (8/20µs)
- ✓ Applications : Security cameras /CATV /RF receivers
- ✓ DC Block series available

# GAS DISCHARGE TUBES (GDT)

The Gas tubes are passive components used to protect telephone exchanges and telecom terminal equipment against overvoltages. They are generally installed on MDF by the telecom operators. They come

in 2 or 3-electrode versions and are available in several discharge capabilities and sparkover voltages.

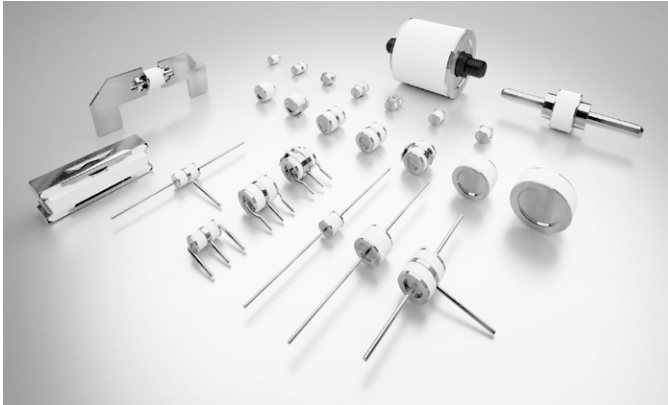

- ✓ 2-electrode or 3-electrode
- ✓ DC sparkover voltage: from 75 V up to 3500 V
- ✓ Discharge current 8/20 $\mu$ s: 2.5 kA, 5 kA, 10 kA, 20 kA, > 100 kA
- ✓ Discharge current 10/350 $\mu$ s: 5 à 100 kA
- ✓ Optional external short-circuit feature
- ✓ Installation on support, on printed circuit or surface-mounted devices

## Head office

France  
Tél. : +33 1 41 23 50 23  
e-mail : [contact@citel.fr](mailto:contact@citel.fr)  
Web : [www.citel.fr](http://www.citel.fr)

## Factory France

Reims  
Tél. : +33 3 26 85 74 00  
e-mail : [contact@citel.fr](mailto:contact@citel.fr)

## Germany

Bochum  
Tél. : +49 234 54 72 10  
e-mail : [info@citel.de](mailto:info@citel.de)  
Web : [www.citel.de](http://www.citel.de)

## USA

Miramar  
Tel : (954) 430 6310  
e-mail : [info@citel.us](mailto:info@citel.us)  
Web site : [www.citel.us](http://www.citel.us)

## China

**Sales department**  
Shanghai  
Tél. : +86 21 58 12 25 25  
e-mail : [info@citelsh.com](mailto:info@citelsh.com)  
Web : [www.citel.cn](http://www.citel.cn)

## Factory

Tél. : +86 21 58 12 80 67

## Russia

Moscou  
Tél. : +7 499 391 47 64  
e-mail : [info@citel.ru](mailto:info@citel.ru)  
Web : [www.citel.ru](http://www.citel.ru)

## India

New Delhi  
Tél. : +91 11 2626 12 38  
e-mail : [indiacitel@gmail.com](mailto:indiacitel@gmail.com)  
Web : [www.citel.in](http://www.citel.in)

## Thailand

Bangkok  
Tél. : +66 (0) 2 104 9214  
Web : [www.citel.fr](http://www.citel.fr)