



CITEL

- UL497E LISTED - I_{max} 20kA (10kA UL) - I_n 10kA (10kA UL) - Bi-directional - Replaceable Gas Tube

P8AX09-6G-T/FF



- Gas Discharge Tube Technology, DC Pass
- Frequency Range 0-6 GHz
- I_{max} 20kA, 10kA (UL), I_n 10kA
- IP67 Outdoor Rated
- SMA Type Connector
- Bi-Directional
- Replaceable Gas Tube

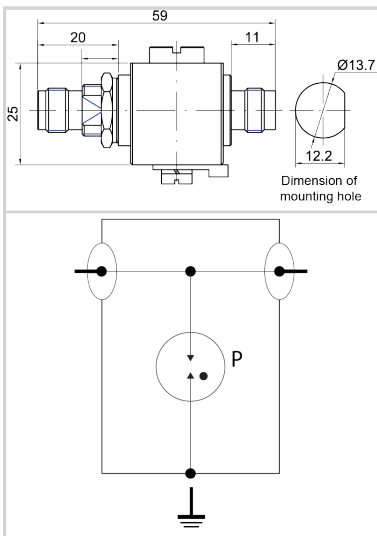

Características eléctricas

Tensión DC máx. de operación	Uc	120 Vdc
Gama de frecuencia	f	DC-6 GHz
Perdida de inserción		0.3 dB
Return loss		> 18 dB
Impedancia		50 ohms
VSWR - ROE		< 1.3:1
Corriente máx. De línea @25°C	IL	10 A
Corriente de descarga máxima <i>Capacidad máx. En onda 8/20µs por polo</i>	I _{max}	15 kA
Corriente de descarga nominal <i>Prueba 8/20µs x 10 - categoría C2</i>	I _n	5 kA
Modo(s) de protección		Modo común
Corriente de choque <i>Prueba 10/350µs x 2 - categoría D1</i>	I _{imp}	1 kA
Potencia máx.		25 W
Típico dejar pasar la energía <i>(50 ohms) entrada 4kV 1.2/50µs - 2kA 8/20µs</i>		2.2 mJ
DC Pass		Yes
Resistencia de aislamiento	IR	≥10 GOhms
RF SPD TYPE		UL497E LISTED
TENSION	(V)	48
AC/DC/DC PV/RF		RF
WIRES		1W+GROUND
LINE CURRENT MAX	(A)	10
AMBIENT MIN	(C)	-40
AMBIENT MAX	(C)	+85
IMAX	(kA)	20
FREQUENCY RANGE	(GHz)	0-6.9
INSERTION LOSS (@ FREQ)	(db)	<0.2
RETURN LOSS	(db)	22
VSWR		<1.25:1

Características mecánicas

Tecnología		Descargador de gas
Conexión a la red		Conector TNC Hembra/Hembra
Montaje		Pasamuros
Temperatura de operación	Tu	-40/+85°C
Clase de protección		IP65
Modo de fallo		Corto-circuito
Contact		Bronce/Superficie Au-Ag
aislamiento		PTFE
TECNOLOGIA		GDT
FORMA DE CONEXION		SERIES CONNECTOR, BI-DIRECTIONAL
MONTAJE		BULKHEAD, OPTIONAL BRACKET
MATERIAL		Cu, Zn, Sn plated Brass, PTFE
NEMA RATING (IP RATING)		NEMA 6P (IP67)
DIMENSIONS		See diagram



CITEL

- UL497E LISTED - I_{max} 20kA (10kA UL) - I_n 10kA (10kA UL) - Bi-directional - Replaceable Gas Tube

P8AX09-6G-T/FF

WEIGHT	0.30 lbs
Normas	
Normas ambientales	EU RoHS
Conformidad RoHs	Si
UL STANDARD	UL497E
UL CATEGORY	QVLA
UL FILE NUMBER	E349646
NORMAS	NOM-003-SCFI-2014, NOM-001-SCFI-1993
Código	
68311	

