



# CITEL

## UL TYPE 1 SPD - I<sub>max</sub> 80kA - I<sub>n</sub> 20kA -Modular DIN RAIL

### DAC84US-240Y/G



- UL1449 5th edition
- Type 1 SPD
- I<sub>max</sub>-80kA
- I<sub>n</sub>-20kA
- Visual fault indicator and remote contacts
- Pluggable/Replaceable Modules
- QR Code Linked Installation Sheet
- 10-Year warranty

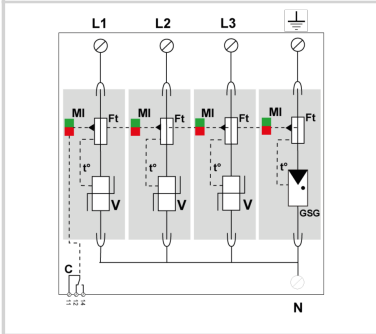
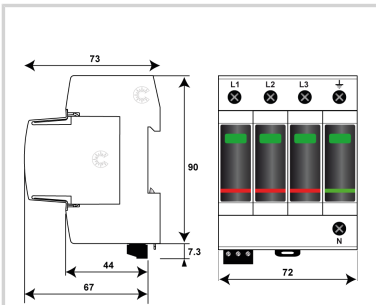

#### Características eléctricas

POWER SPD TYPE		UL1449 TYPE 1 LISTED
TENSION	(V)	415/240
AC/DC/DC PV/RF		AC
FASE	(PH)	3Y
AMPS	(A)	N/A
AMBIENT MIN	(C)	-40
AMBIENT MAX	(C)	+85
MODOS		L-L, L-N, L-G, N-G
VPR	(V)	1800/1000/1200/1200
MCOV	(V)	640/320/320/255
I <sub>N</sub>	(kA)	20
I <sub>cc</sub> cortocircuito	(kA)	200
I <sub>MAX</sub>	(kA)	80
RELATIVE HUMIDITY	(%)	95%

#### Características mecánicas

TECNOLOGIA		Multi-MOV+GSG
CONFIGURACION DE RED		3PH, 4W+G, Wye
FORMA DE CONEXION		Screw Terminal (4-14AWG)
MONTAJE		DIN RAIL
MATERIAL		Thermoplastic UL94-V0
NEMA RATING (IP RATING)		NEMA 2 (IP20)
DESCONEXION SEGURA		Yes, no upstream over current protection required
REAL-TIME DIAGNOSTICS		Visual indicator and remote contacts
DIMENSIONS		See diagram
WEIGHT		1.32 lbs

#### Normas

Certificación		UL Listed
Normas ambientales		EU RoHS
UL STANDARD		UL1449 5th Edition
UL CATEGORY		VZCA, VZCA7
UL FILE NUMBER		E326289
NORMAS		NOM-003-SCFI-2014, NOM-001-SCFI-1993

#### Código

55110060

