



CITEL

- UL TYPE 1 LISTED - I_{max} 192kA per phase - I_n 20kA - NEMA Enclosure

MS160-120Y



- I_{max} 105-220kA per phase
- UL1449 Type 1 Listed SPD
- I_n 20kA
- SCCR 200kA
- Real-Time LED indicators, Audible Alarm, Remote Contacts
- Smart Diagnostic Indicating % protection present
- NEMA 4 (Other options NEMA 12, NEMA 4X Stainless Steel)
- UL1283 EMI Filter (Option available)
- Surge Counter (Option available)

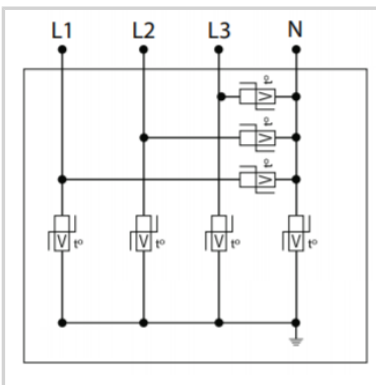

Características eléctricas	
POWER SPD TYPE	UL1449 TYPE 1 LISTED
TENSION	(V) 120/208
AC/DC/DC PV/RF	AC
FASE	(PH) 3Y
AMPS	(A) N/A
AMBIENT MIN	(C) -35
AMBIENT MAX	(C) +85
MODOS	L-L, L-N, L-G, N-G
VPR	(V) 1000/700/700/700
MCOV	(V) 300/150/150/150
IN	(kA) 20
IMAX	(kA) 192
Características mecánicas	
TECNOLOGIA	Multi-TMOV
CONFIGURACION DE RED	3PH, 4W+G, Wye
FORMA DE CONEXION	36" #10 AWG LEADS
MONTAJE	FLANGE MOUNT
MATERIAL	Steel
NEMA RATING (IP RATING)	NEMA 3R,4, 12 (IP65)
DESCONEXION SEGURA	Yes, no upstream over current protection required
REAL-TIME DIAGNOSTICS	% of protection present LED, audible alarm and remote contacts. Optional surge counter.
DIMENSIONS	See diagram
WEIGHT	6 lbs
Normas	
UL STANDARD	UL1449 5th Edition
UL CATEGORY	VZCA, VZCA7
UL FILE NUMBER	E326289
NORMAS	NOM-003-SCFI-2014, NOM-001-SCFI-1993
ENVIRONMENTAL STANDARDS	ROHS
Código	
890164	

