

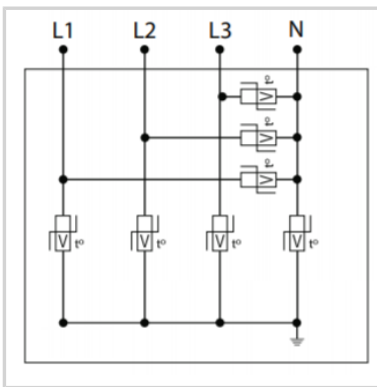

CITEL



M200-120Y



Electrical Characteristics

POWER SPD TYPE		UL1449 TYPE 2 LISTED
VOLTS	(V)	120/208
AC/DC/DC PV/RF		AC
PHASE	(PH)	3Y
AMPS	(A)	N/A
AMBIENT MIN	(C)	
AMBIENT MAX	(C)	
MODES		L-L, L-N, L-G, N-G
VPR	(V)	1800/800/900/800
MCOV	(V)	300/150/150/150
IN	(kA)	5
15 impulses 8/20 μ s		
IMAX	(kA)	200
8/20 μ s		

Mechanical Characteristics

TECHNOLOGY		MOV
NETWORK CONFIGURATION		3PH, 4W+G, Wye
CONNECTION METHOD		36" #10 AWG LEADS
MOUNTING		FLANGE MOUNT
MATERIAL		Steel
NEMA RATING (IP RATING)		1/12
FAIL-SAFE BEHAVIOR		30A upstream overcurrent device
REAL-TIME DIAGNOSTICS		LED, audible alarm and remote contacts.
DIMENSIONS		See diagram
WEIGHT		8 lbs

Standards

Environmental standards		EU RoHS
UL STANDARD		UL1449 5th Edition
UL CATEGORY		VZCA, VZCA7
UL FILE NUMBER		E326289
STANDARDS		NOM-003-SCFI-2014, NOM-001-SCFI-1993

Part number

89072277

