



CITEL



MP100-240Y

- ▶ Multi-TMOV Technology
- ▶ UL1449 Type 1 LISTED
- ▶ 132kA I_{max} Surge Current Rating
- ▶ Visual fault indicator
- ▶ 10-Year warranty

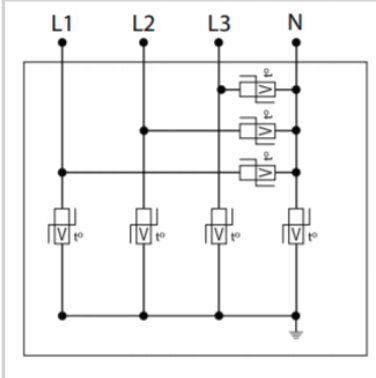
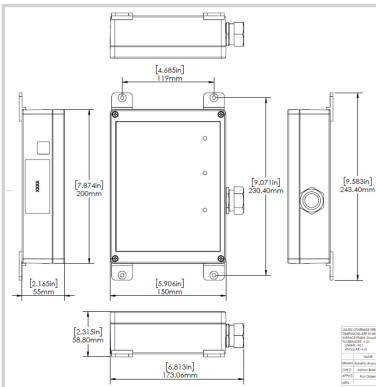

Electrical Characteristics

POWER SPD TYPE		UL1449 TYPE 1 LISTED
VOLTS	(V)	240/415
AC/DC/DC PV/RF		AC
PHASE	(PH)	3Y
AMPS	(A)	N/A
AMBIENT MIN	(C)	-35
AMBIENT MAX	(C)	85
MODES		L-L, L-N, L-G, N-G
VPR	(V)	1800/1000/1200/1000
MCOV	(V)	640/320/320/320
IN	(kA)	20
15 impulses 8/20 μ s		
IMAX	(kA)	132
8/20 μ s		

Mechanical Characteristics

TECHNOLOGY		Multi-TMOV
NETWORK CONFIGURATION		3PH, 4W+G, Wye
CONNECTION METHOD		3/6" #10 AWG LEADS
MOUNTING		FLANGE MOUNT
MATERIAL		Polycarbonate
NEMA RATING (IP RATING)		4X (IP67)
FAIL-SAFE BEHAVIOR		Yes, no upstream over current protection required
REAL-TIME DIAGNOSTICS		LED Visual Status Indicators
DIMENSIONS		See diagram
WEIGHT		6 lbs

Standards

Environmental standards		EU RoHS
UL STANDARD		UL1449 5th Edition
UL CATEGORY		VZCA, VZCA7
UL FILE NUMBER		E326289
STANDARDS		NOM-003-SCFI-2014

Part number

891852

