



CITEL



MP100-240D

- ▶ Multi-TMOV Technology
- ▶ UL1449 Type 1 LISTED
- ▶ 132kA I_{max} Surge Current Rating
- ▶ Visual fault indicator
- ▶ 10-Year warranty

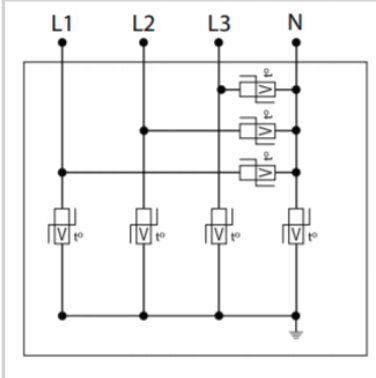
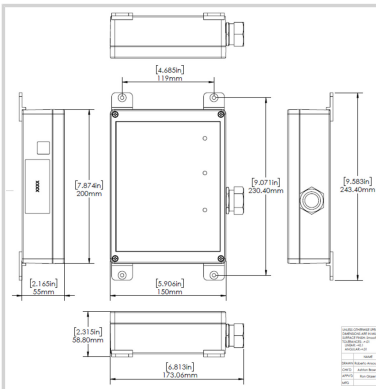

Características eléctricas

POWER SPD TYPE		UL1449 TYPE 1 LISTED
TENSION	(V)	240
AC/DC/DC PV/RF		AC
FASE	(PH)	3D
AMPS	(A)	N/A
AMBIENT MIN	(C)	-40
AMBIENT MAX	(C)	85
MODOS		L-L, L-G
VPR	(V)	1800/-/1200/-
MCOV	(V)	640/-/320/-
IN	(kA)	20
IMAX	(kA)	132

Características mecánicas

TECNOLOGIA		Multi-TMOV
CONFIGURACION DE RED		3PH, 3W+G, Delta
FORMA DE CONEXION		36" #10 AWG LEADS
MONTAJE		FLANGE MOUNT
MATERIAL		Polycarbonate
NEMA RATING (IP RATING)		4X (IP67)
DESCONEXION SEGURA		Yes, no upstream over current protection required
REAL-TIME DIAGNOSTICS		LED Visual Status Indicators
DIMENSIONS		See diagram
WEIGHT		6 lbs

Normas

Normas ambientales		EU RoHS
UL STANDARD		UL1449 5th Edition
UL CATEGORY		VZCA, VZCA7
UL FILE NUMBER		E326289
NORMAS		NOM-003-SCFI-2014

Código

891823

