



# CITEL

INSTALLATION INSTRUCTIONS - NOTICE D'INSTALLATION  
 NOTICIA DE INSTALACION - INSTALLATIONSHINWEISE  
 ISTRUZIONI PER L'INSTALLAZIONE  
 INSTRUCOES DE INSTALACAO - MONTÁŽNÍ NÁVOD  
 РУКОВОДСТВО ПО МОНТАЖУ - 安裝指導書

Parafoudre Type 2 (ou Type 3) très compact pour éclairage à LED.  
 AC surge protector Type 2 (or Type 3) for LED lighting system.

Protección AC contra sobretensiones transitorias de Tipo 2 (o 3) para iluminación con tecnología LED.  
 Protezione AC contro sovratensioni di Tipo 2 (o 3) per l'illuminazione con tecnologia LED.  
 УЗМІІ переменного тока Класс 2 (или Класс 3) для светодиодных систем освещения.  
 Střídavá přepětová ochrana Typu 2 (nebo Typu 3) pro LED osvětlovací systémy.

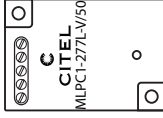
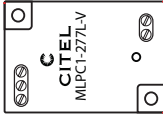

## MLPC Range

## Application example

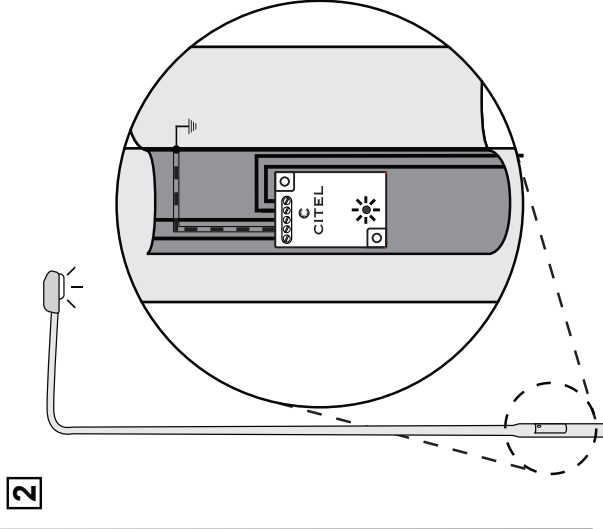
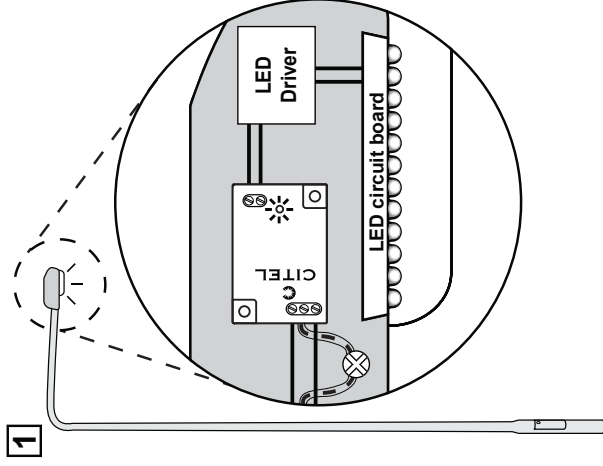

## Technical Data

2000 m max.  
6500 ft max.

-40/+85°C max.  
-40/+185°F max.  
Indoor use only

### AC network

120-277 Vac single phase

### Characteristics

Connection by wire

I<sub>max</sub> 10 kA

I<sub>pe</sub> no current

Protection class IP20

Table 1

P/N	MLPC1-277L-V/50	MLPC1-2-770L-V
AC network		
120-277 Vac single phase	●	●
Characteristics		
Connection by wire	●	●
I <sub>max</sub>	10 kA	
I <sub>pe</sub>	no current	
Protection class	IP20	

## Wiring and installation

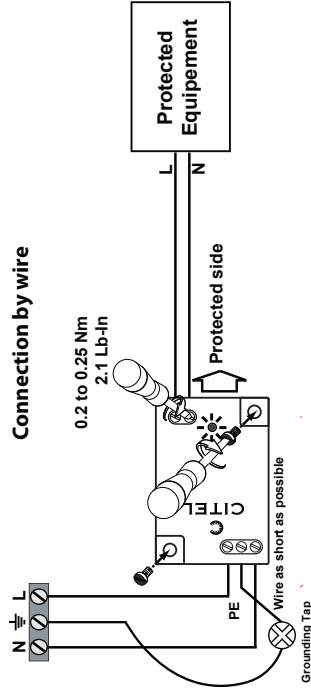

## Dimensions (in mm)

MLPC1-277L-V  
MLPC1-277L-V/50

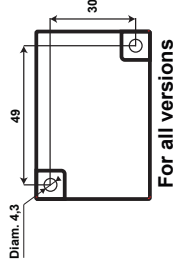
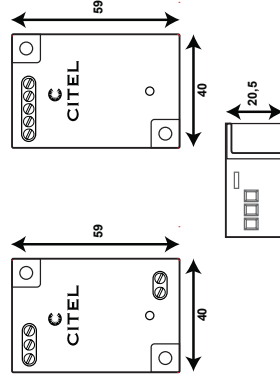

## Maintenance

